

08PLAST-2440

Banco 08PLAST, fabricado en Polipropileno y Poliamida 66+GFR de medidas 2440x595x830 mm, disponible en varios colores.

Revision: 01 - 22/05/2023



Imagen - 08PLAST-2440-AMA (Color amarillo)

08PLAST-2440

Banco 08PLAST, fabricado en Polipropileno y Poliamida 66+GFR de medidas 2440x595x830 mm, disponible en varios colores.

Revision: 01 - 22/05/2023

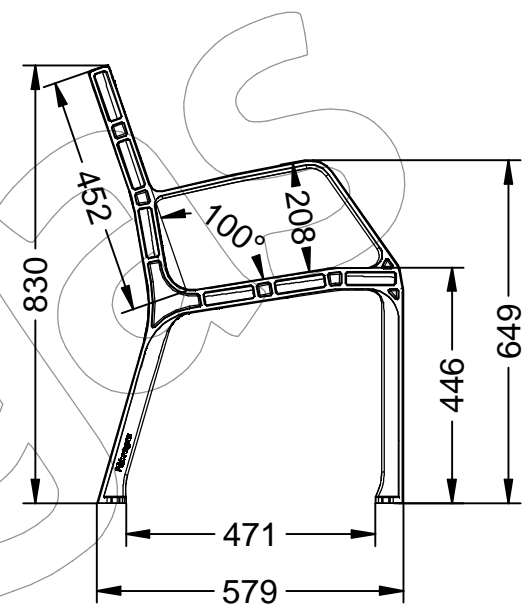
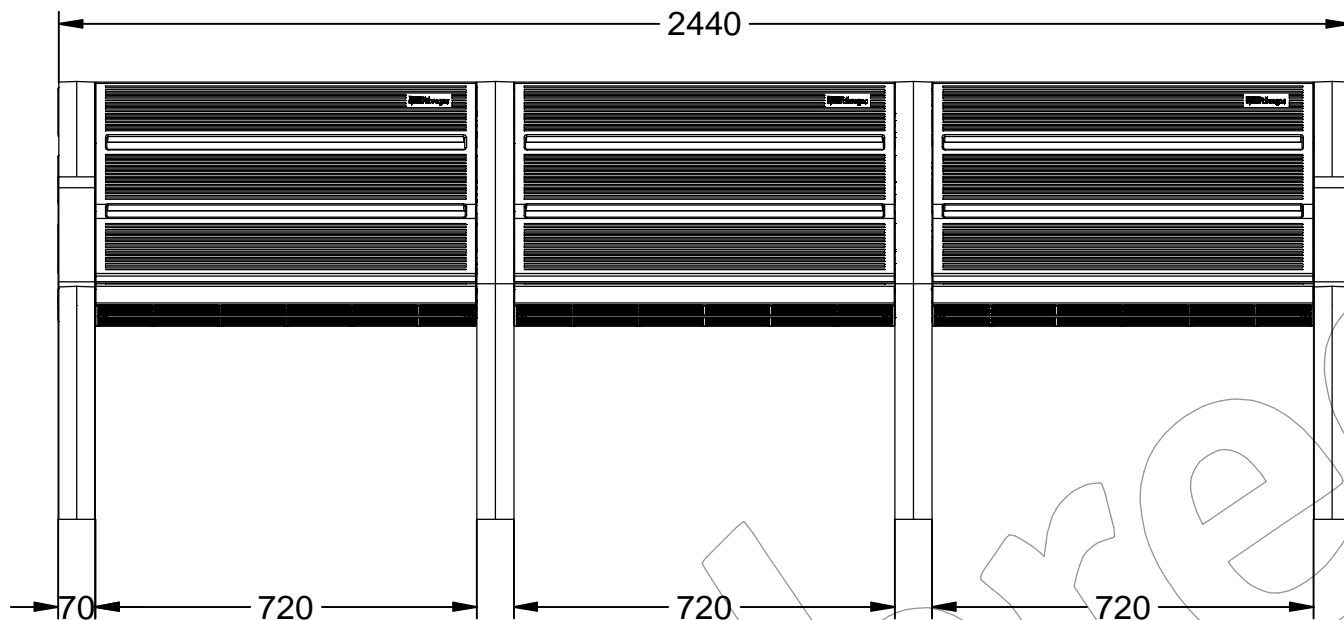
Disponible en varios colores

08PLAST-2440-AMA (RAL 1021)



08PLAST-2440-AZU (RAL 5005)



08PLAST-2440-COR (Color corten)



08PLAST-2440-PLA (Color plata)



08PLAST-2440-ROJ (RAL 3020)



08PLAST-2440-VER (RAL 6029)

08PLAST-2440

Banco 08PLAST, fabricado en Polipropileno y Poliamida 66+GFR de medidas 2440x595x830 mm, disponible en varios colores.

Revision: 01 - 22/05/2023



-ES- 

Descripción: Banco modelo MODO08-PLAST de polipropileno de alta calidad, de medidas 2440x595x830 mm.

Materiales: Asiento y respaldo en Polipropileno (PP).
Pies: Poliamida 66 + 30% GF.

- Tratado con UV.
- Sin mantenimiento.
- Antigrafiti.
- Gran robustez.

- Embalaje: Paletizado y plastificado.

- Disponible en varios colores:
- Color amarillo RAL 1021.
- Color azul RAL 5005
- Color corten
- Color plata
- Color rojo RAL 3020
- Color verde RAL 6029

-EN- 

Description: Bench model MODO08-PLAST in polypropylene high quality, measures 2440x595x830 mm.

Materials: Seat and back in Polypropylene (PP).
Feet: Polyamide 66 + 30% GF.

- UV treated.
- Without maintenance.
- Anti-graffiti.
- Great robustness.

- Packaging: Palletized and laminated.

- Available in various colors:
- Yellow color RAL 1021.
- Blue color RAL 5005
- Corten color
- Silver color
- Red color RAL 3020
- Green color RAL 6029

-PT- 

Descrição: Banco modelo MODO08-PLAST em polipropileno alta qualidade, mede 2440x595x830 mm.

Materiais: Assento e encosto em Polipropileno (PP).
Pés: Poliamida 66 + 30% GF.

- Tratamento UV.
- Sem manutenção.
- Anti-grafite.
- Grande robustez.

- Embalagem: Paletizado e laminado.

- Disponível em várias cores:
- Cor amarelo RAL 1021.
- Cor azul RAL 5005
- Cor Corten
- Cor Prata
- Cor vermelha RAL 3020
- Cor verde RAL 6029

-CA- 

Descripció: Banc model MODO08-PLAST de polipropilè d'alta qualitat, de mides 2440x595x830 mm.

Materials: Seient i respallter a Polipropilè (PP).
Peus: Poliamida 66+30% GF.

- Tractat amb UV.
- Sense manteniment.
- Antigrafiti.
- Gran robustesa.

- Embalatge: Paletitzat i plastificat.

- Disponible en diversos colors:
- Color groc RAL 1021.
- Color blau RAL 5005
- Color còrten
- Color plata
- Color vermell RAL 3020
- Color verd RAL 6029

-FR- 

Description: Banque modèle MODO08-PLAST en polypropylène de haute qualité, mesure 2440x595x830 mm.

Matériaux: Assise et dossier en polypropylène (PP).
Pieds: Polyamide 66 + 30% GF.

- Traité anti-UV.
- Sans entretien.
- Anti-graffitis.
- Grande robustesse.

- Conditionnement : Palettisé et laminé.

- Disponible en différentes couleurs:
- Couleur jaune RAL 1021.
- Couleur bleu RAL 5005
- Couleur corten
- Couleur argent
- Couleur rouge RAL 3020
- Couleur vert RAL 6029